



Heater-Shaker Module GEN1

Instruction Manual



Opentrons Labworks Inc.

Edition
GEN1, August 2022

Table of Contents

Product and Manufacturer Description	3
– Product Description	
– Manufacturer Description	
Safety Information and Regulatory Compliance	4
– Safe Use Specifications	
– LED Status Light	
– Safety Warning Labels	
– Standards Compliance	
Product Specifications	10
– Model Number	
– Included Parts	
– Thermal Adapters	
– Physical Specifications	
– Power Consumption	
– Shaking Profile	
– Temperature Profile	
– Liquid Classes and Volumes	
– Supported Labware	
Setup and Maintenance	13
– In-app Setup Guide	
– Setup Steps	
– Software Control	
– Maintenance	
Support	21
– Opentrons Help Center	
– Contact Opentrons	
– Warranty	

Product and Manufacturer Description

PRODUCT DESCRIPTION

The Opentrons Heater-Shaker Module GEN1 provides on-deck heating and orbital shaking. The module can be heated to 95 °C, and can shake samples from 200 to 3000 rpm.

MANUFACTURER DESCRIPTION

Opentrons Labworks Inc

45-18 Ct Square W

Long Island City, NY 11101

Safety Information and Regulatory Compliance

Opentrons strongly recommends that you follow the safe use specifications listed in this section and throughout this manual.

The shaking motion of the Heater-Shaker **requires additional anchoring** — more than simply clipping it into a deck slot — to ensure that it does not dislodge itself from the deck of your robot. See the Setup Steps section of this manual or the on-screen instructions in the Opentrons App for details on how to anchor the module.

SAFE USE SPECIFICATIONS

Input and Output Connections

The Heater-Shaker has the following power input and output requirements, which are met by the included power supply brick.

Warning: Do **not** replace the power supply cord unless at the direction of Opentrons Support.

Power Supply (AC):

- **Voltage:** 100–240 V
- **Frequency:** 50/60 Hz
- **Current:** 4.0 A
- **Mains supply voltage fluctuation:** $\pm 10\%$
- **Overvoltage:** Category II

Heater-Shaker (DC):

- **Voltage:** 36 V
- **Current:** 6.1 A

These input and output requirements are also indicated on the external power adapter.

Safety Information and Regulatory Compliance

Environmental Conditions

For optimal performance, Opentrons recommends using the Heater-Shaker in the following conditions:

- **Environment:** Indoor use only
- **Temperature:** 20–25 °C
- **Relative humidity:** 80% maximum, non-condensing
- **Altitude:** Up to 2,000 meters above sea level
- **Pollution degree:** 2

The Heater-Shaker can be safely transported and stored at temperatures of –10 to 60 °C.

Software Requirements

The Heater-Shaker requires version 6.1.0 or newer of the Opentrons App and OT-2 robot server.

You can download the Opentrons App for Windows, macOS, or Ubuntu at <https://opentrons.com/ot-app/>.

Safety Information and Regulatory Compliance

LED STATUS LIGHT

The Heater-Shaker has an LED status light that can display three colors: amber, red, and white. Reading these status indications is important for safe handling of the module (see Temperature Safety below). The possible module conditions indicated by the light are:

LED COLOR AND BEHAVIOR	MODULE CONDITIONS
Pulsing red	Module is heating
Solid red	Module is holding at target temperature and/or Module is hot to the touch (>49 °C)
Solid white	Module is on and idle and/or Module has been deactivated and it is not hot to the touch (<49 °C)
Pulsing white	Module is in identify mode (to distinguish between multiple Heater-Shaker Modules)
Pulsing amber	Module is in an error state
Pulsing red and amber, alternating	Module is in an error state and Module is hot to the touch (>49 °C)
Pulsing red and white, alternating	Module is in identify mode and Module is heating
LED off	Module is powered off

Safety Information and Regulatory Compliance

Temperature Safety

During normal operation, the top plate, labware adapters, and labware on top of the Heater-Shaker can reach **temperatures of up to 95 °C**. Touching these surfaces while they are hot poses the risk of burns.

To reduce the risk of burns, always check the color of the status light before touching the module. If the status **light is red**, the module may be hot to the touch. **Do not touch** the module. Use the Opentrons App to deactivate the heater and allow the module to cool until the status light is solid white.

If you must touch a module that is powered off, and you are unsure whether it is hot to the touch:

- If you can do so *without touching any other part of the module*, press the power button to activate the module and check the color of the status light.
- If you cannot safely press the power button, allow the module to cool for at least 10 minutes before touching it.

Powering Down

When powering down the Heater-Shaker Module, ensure that it is idle (not shaking) and not hot to the touch by checking that its status light is solid white. If the status light is red, the module is hot; allow the module to cool until the status light is white before powering it down. Powering down the module while the status light is red prevents other users from determining whether the module is hot to the touch.

Press the power button above the USB connector to turn off the module. You can unplug the power adapter once the module is powered down.

Safety Information and Regulatory Compliance

SAFETY WARNING LABELS

Warning labels on the Heater-Shaker indicate sources of potential injury or harm.



Hot Surface: This symbol identifies instrument components that, if handled improperly, pose a risk of personal injury due to high temperature (>49 °C).

STANDARDS COMPLIANCE

The Heater-Shaker has been tested and found to be in compliance with all applicable requirements of the following safety and electromagnetic standards:

Safety

- IEC/EN 61010-1 Safety Requirements for Electrical Equipment for Measurement, Control and Laboratory Use
- IEC 61010-2-010 Requirement for Heating
- IEC 61010-2-051:2018 Particular requirements for laboratory equipment for mixing and stirring

Electromagnetic Compatibility

- FCC part 15 subpart B class A
- IEC/EN 61326-1 EMC Testing of Laboratory Equipment

Hazardous Substances: RoHS compliant

Safety Information and Regulatory Compliance

FCC Warnings and Notes

Warning: Changes or modifications to this unit not expressly approved by Opentrons Labworks Inc. could void the user's authority to operate the equipment.

Note: This equipment has been tested and found to comply with the limits for a Class A digital device, pursuant to part 15 of the FCC Rules. These limits are designed to provide reasonable protection against harmful interference when the equipment is operated in a commercial environment. This equipment generates, uses, and can radiate radio frequency energy and, if not installed and used in accordance with the instruction manual, may cause harmful interference to radio communications. Operation of this equipment in a residential area is likely to cause harmful interference in which case the user will be required to correct the interference at his own expense.

Note regarding FCC compliance: Although this instrument has been tested and found to comply with Part 15, Subpart B of the FCC Rules for a Class A digital device, please note that this compliance is voluntary, for the instrument qualifies as an "exempted device" under 47 CFR 15.103(c), in regard to the cited FCC regulations in effect at the time of manufacture.

CISPR 11 Class A

Caution: This equipment is not intended for use in residential environments and may not provide adequate protection to radio reception in such environments.

Product Specifications

MODEL NUMBER

GEN1

INCLUDED PARTS

- (1) Power Supply
- (1) Power Cable
- (1) USB Cable
- (1) T10 Torx Screwdriver
- (1) T10 Torx L Key
- (1) M3x7 Thermal Adapter Screw (plus spares)

THERMAL ADAPTERS

A compatible thermal adapter is required for adding labware to the Heater-Shaker Module. Adapters can be purchased directly from Opentrons at <https://shop.opentrons.com>.

Currently available Thermal Adapters include:

- Universal Flat Adapter
- PCR Adapter
- Deep Well Adapter
- 96 Flat Bottom Adapter

PHYSICAL SPECIFICATIONS

All specifications are for the module as shipped: with latches in the rest position and without labware or adapters.

- **Dimensions:** 152 mm L x 90 mm W x 82 mm H
- **Weight:** 1.34 kg
- **Composition:** CNC aluminum and polycarbonate plastic

Product Specifications

POWER CONSUMPTION

These are typical power consumption values measured at the wall outlet. Typical power consumption is when the module is maintaining temperatures and shake speeds in the normal range. The maximum power consumption is when the module is simultaneously heating at full power and shaking at maximum speed.

Idle: 3 W

Typical consumption:

- **Shaking:** 4–11 W
- **Heating:** 10–30 W
- **Heating and shaking:** 10–40 W

Maximum consumption: 125–130 W

SHAKING PROFILE

- **Orbital diameter:** 2.0 mm
- **Orbital direction:** Clockwise
- **Speed range:** 200–3000 rpm (some labware may recommend a lower maximum rpm)
- **Speed accuracy:** ± 25 rpm

TEMPERATURE PROFILE

- **Temperature range:** 37–95 °C
- **Temperature accuracy:** ± 0.5 °C at 55 °C
- **Temperature uniformity:** ± 0.5 °C at 55 °C
- **Ramp rate:** 10 °C/min

Product Specifications

LIQUID CLASSES AND VOLUMES

For further information, consult the most recent application notes and white papers available on the [Heater-Shaker product page](#) on the Opentrons website.

SUPPORTED LABWARE

- NEST 96 Well, 0.1mL, Round Well, V Bottom, Full Skirt
- NEST 96 Well, 0.2mL, Round Well, Flat Bottom, Full Skirt
- NEST 96 Well, Deep Well, 2mL, Square Well, V Bottom, Full Skirt
- Thermo Scientific Armadillo PCR Plate, 96-Well, Clear, Clear Wells
- Corning 384 Well Plate 112 μ L Flat

Custom flat-bottom labware can be used with the Universal Flat Adapter. If you need assistance creating custom labware definitions for the Heater-Shaker, [submit a request](#).

Setup and Maintenance

IN-APP SETUP GUIDE

For interactive setup instructions and to run a test shake with your Heater-Shaker Module, connect the module to your robot (see Connecting USB & Power below) and either:

- Go to the **Pipettes and Modules** section on the robot's device detail page, or
- Load a protocol that requires the module and go to **Step 2: Module Setup** in the Setup tab of the protocol run page.

SETUP STEPS

Preparing the Module

- 1 Orient the module so its ports face away from you.
- 2 Make sure the anchors are not extended and are level with the module's base. Turn the screws above each anchor counterclockwise to retract the anchors. The screws should not come out of the module.

Setup and Maintenance

Attaching to Deck

- 3 Choose which slot you will place the Heater-Shaker in. Slots 1, 3, 4, 6, 7, and 10 are supported.

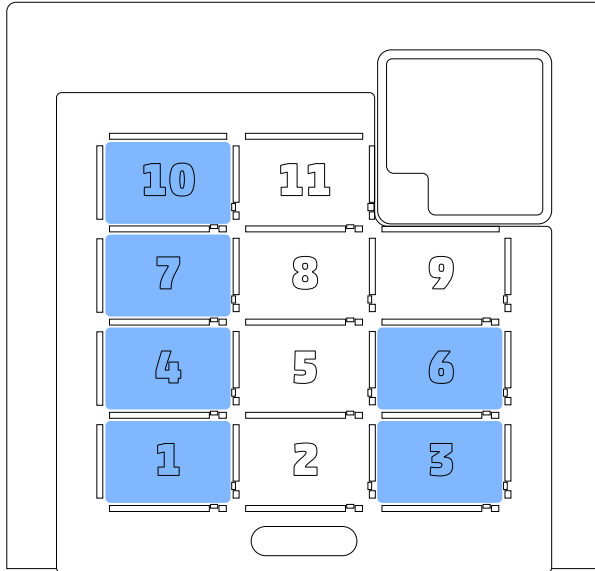

- 4 Place the module in the slot such that the power and USB ports are facing **outward**, i.e. to the left in slot 1, 4, 7, or 10; to the right in slot 3 or 6.

Setup and Maintenance

- 5 Hold the module flat against the deck and turn the screws clockwise to extend the anchors.

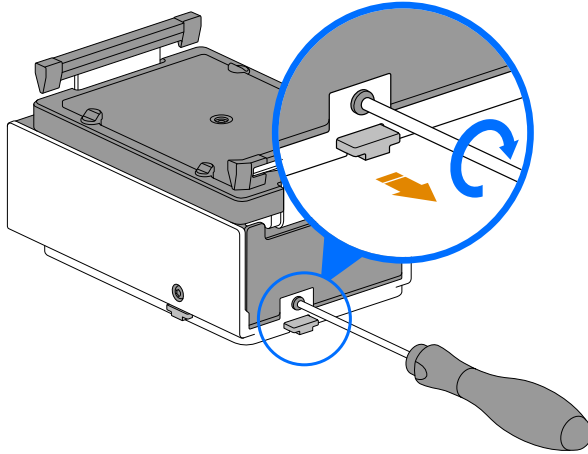

- 6 Check that the module is firmly attached by gently pulling up on it and rocking it from side to side.

Setup and Maintenance

Attaching a Thermal Adapter

- 7 Use the included T10 Torx Screwdriver and Thermal Adapter Screw to attach your chosen adapter to the module.

IMPORTANT:

Using a different screwdriver can strip the screws. Using different screws can damage the module.

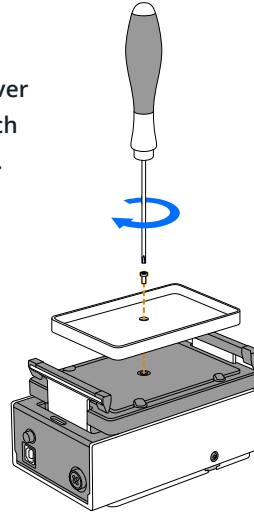

- 8 Check the alignment of the thermal adapter. If properly attached, it will sit evenly on the module.



- 9 Check that the adapter is firmly attached by rocking it back and forth.

Setup and Maintenance

Connecting USB & Power

- 10 The module requires two connections:
1. Connect the power cable to the power supply and the module. Route the cable through the gap at the bottom of the robot's side window.
 2. Connect the USB cable to the module and an open USB port at the back of the robot. Use the cable holders on the side of the robot to keep the USB cable out of the way.

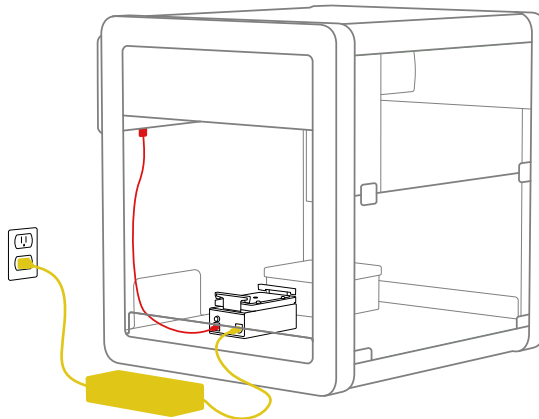

- 11 Power on the robot and module, and launch the Opentrons App.

If you successfully connected your module, it will appear in the **Pipettes and Modules** section on your robot's device detail page. From there you can control the module's labware latch or run a test shake.

Setup and Maintenance

SOFTWARE CONTROL

The Heater-Shaker Module can be controlled in JSON ([Protocol Designer](#)) and [Python protocols](#). Running these protocols requires version 6.1.0 or newer of the Opentrons App and OT-2 robot server.

The Opentrons App displays the current status of the Heater-Shaker and can also control the module outside of protocols. To control a Heater-Shaker, go to the **Devices** tab and select the robot that it is connected to. Robots with a connected and powered on Heater-Shaker will have a 🔌 icon under the Modules section of the device card.

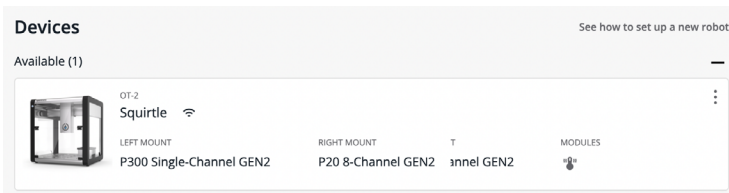

On the device detail page, a module card shows the current status of the Heater-Shaker, including:

- Whether the heater is heating, cooling, or holding at target. A warning banner will appear if the module is hot to the touch (>49 °C).
- The target (if set) and current temperature
- Whether the shaker is speeding up, slowing down, or holding at target
- The target (if set) and current shake speed
- Whether the labware latch is open or closed

Setup and Maintenance

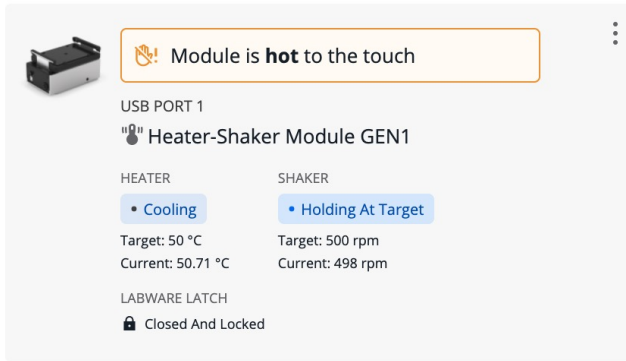

Click the three-dot menu  to reveal the available controls for the Heater-Shaker. You can control the heater, shaker, and labware latch independently. You can also view information about the module, including its serial number and firmware version, or launch the in-app attachment guide.

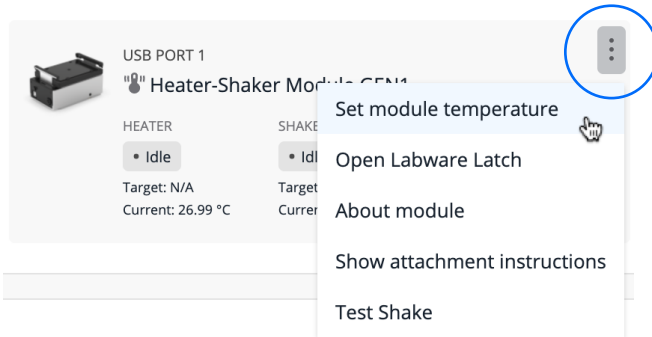

Setup and Maintenance

MAINTENANCE

Device Lifetime

The Heater-Shaker has been tested for 3 years of full-time operation (more than 1000 total hours) without maintenance.

Service and Repair

Users should not attempt to service or repair the module themselves. If you have concerns about your module's performance or require service, please contact Opentrons Support.

Cleaning

Before cleaning the Heater-Shaker, unplug the power and USB cables and remove it from the deck.

All outer surfaces of the Heater-Shaker are compatible with:

- 10% bleach solution
- 70% ethanol
- 99% isopropyl alcohol

Spray one of these cleaners onto a paper towel and use it to wipe the exterior surfaces of the module. Avoid introducing these substances into the USB port or power port. Never douse or spray the module directly with cleaner.

The module can also withstand ultraviolet (UV) light, limited to standard sterilization procedures. Do not expose the module to constant or high-intensity UV light.

Support

OPENTRONS HELP CENTER

Answers to many common questions are available on the Opentrons Help Center at <http://support.opentrons.com/>.

CONTACT OPENTRONS

If you have any other questions, contact support@opentrons.com. Please have the serial numbers of your module and robot available when contacting support.

WARRANTY

All hardware purchased from Opentrons is covered under a 1-year standard warranty. Opentrons warrants to the end-user of the products that they will be free of manufacturing defects due to part quality issues or poor workmanship and also warrants that the products will materially conform to Opentrons' published specifications.

